



WORK GRIPPER

Option

LV-3

■ Air Lock Valve Unit

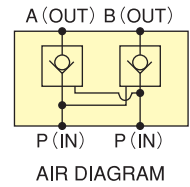
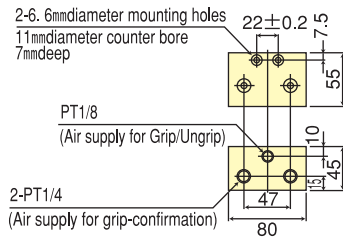
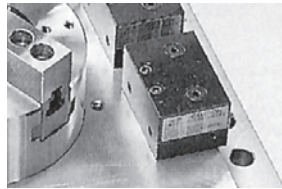

AV-02F

■ Original manual air valve by **KITAGAWA**

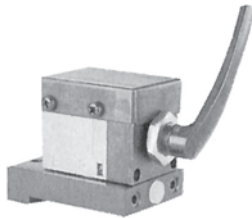

AV-02F allows air system to be simplified

※ Valves can be easily mounted onto work gripper and multiplate.

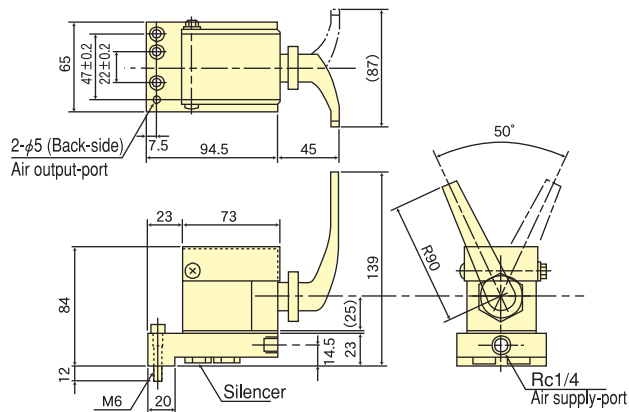

■ Mounting Drawing (by AV-02F)

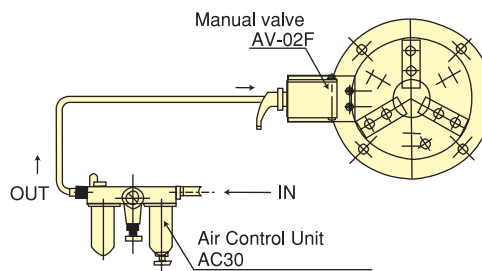

Max. pressure	1MPa (10kgf/cm ²)
Lever movement	50°
Connection port	Rc1/4

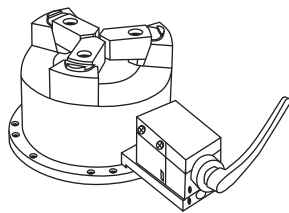

VH-201

■ Manual Air Valve



Max. pressure	1MPa (10kgf/cm ²)
Lever movement	90°
Connection port	Rc1/4

■ Mounting Drawing (by VH-201)

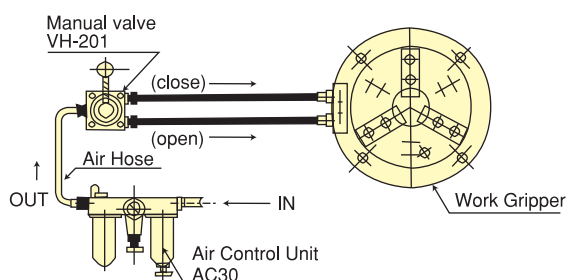

AC30

■ Air Control Unit (With Lubrication)

Max. pressure	1MPa (10kgf/cm ²)
Pressure setting range	0.05~0.85MPa (0.5~8.6kgf/cm ²)
Filter mesh	5μm
Max. temperature	60°C
Connection port	Rc1/4